

2329915-1 ✓ ACTIVE

[Power Versa-Lock](#) | [Power Versa-Lock 5.0](#)

TE Internal #: 2329915-1

Power Versa-Lock 5.0, Power Contacts, Contact, Operating Voltage 600 VAC, Operating Voltage 600 VDC, Pre-Tin, 26 – 22AWG Wire Size

[View on TE.com >](#)



Connectors > Power Connectors > Power Contacts

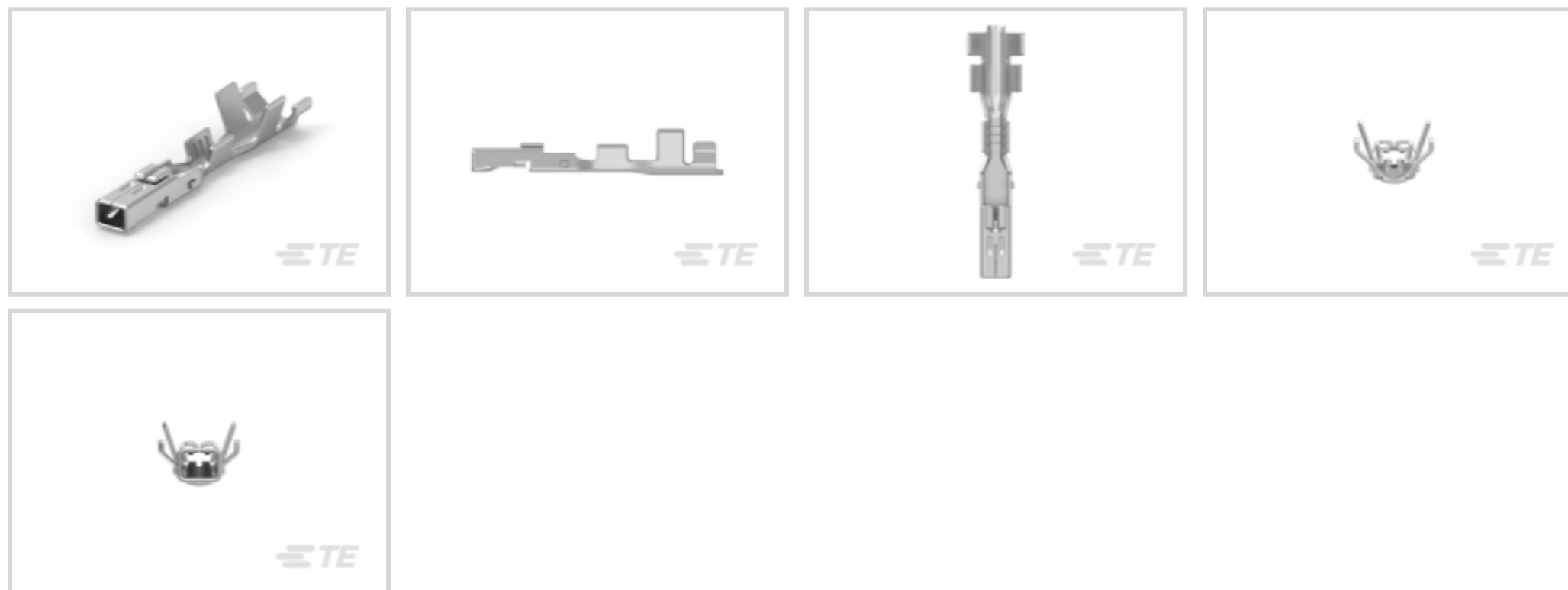

Power Contact Type: **Contact**

Operating Voltage: **600 VDC**

Contact Mating Area Plating Material: **Pre-Tin**

Wire Size: **26 – 22 AWG**

## Features

### Product Type Features

Power Contact Type	Contact
Connector System	Wire-to-Wire
Sealable	No
Connector & Contact Terminates To	Wire & Cable

### Electrical Characteristics

Continuous Current Rating	5 A
Operating Voltage	600 VDC

### Contact Features

Contact Mating Area Plating Material	Pre-Tin
Contact Current Rating (Max)	5 A
Contact Type	Receptacle
Contact Retention Within Housing	Without
Mating Tab Width	1.5 mm[.06 in]
Mating Tab Thickness	.5 mm[.02 in]
Contact Base Material	Copper Alloy



Wire Contact Termination Area Plating Material	Pre-Tin
--	---------

Contact Orientation	Straight
---------------------	----------

### Termination Features

Termination Method to Wire & Cable	Crimp
------------------------------------	-------

### Mechanical Attachment

Carrier Strip Mount Orientation	Side Feed
---------------------------------	-----------

Connector Mounting Type	Panel Mount
-------------------------	-------------

Wire Insulation Support	With
-------------------------	------

### Dimensions

Wire Size	.13 – .3 mm <sup>2</sup>
-----------	--------------------------

Accepts Wire Insulation Diameter Range	1.3 – 2.1 mm [.051 – .083 in]
--	-------------------------------

### Usage Conditions

Operating Temperature Range	-30 – 105 °C [-22 – 221 °F]
-----------------------------	-----------------------------

### Operation/Application

Circuit Application	Power
---------------------	-------

### Packaging Features

Packaging Method	Reel
------------------	------

### Other

Wire/Cable Type	Discrete Wire
-----------------	---------------

Wire Type	Stranded
-----------	----------

For Use With	Plug Housing
--------------	--------------

### Product Compliance

[For compliance documentation, visit the product page on TE.com>](#)

EU RoHS Directive 2011/65/EU	Compliant
------------------------------	-----------

EU ELV Directive 2000/53/EC	Compliant
-----------------------------	-----------

China RoHS 2 Directive MIIT Order No 32, 2016	No Restricted Materials Above Threshold
---	---

EU REACH Regulation (EC) No. 1907/2006	Current ECHA Candidate List: JUL 2021 (219) Candidate List Declared Against: JAN 2021 (211) SVHC > Threshold: Not Yet Reviewed
--	---



Halogen Content	Low Halogen - Br, Cl, F, I < 900 ppm per homogenous material. Also BFR/CFR/PVC Free
Solder Process Capability	Not reviewed for solder process capability

Product Compliance Disclaimer

This information is provided based on reasonable inquiry of our suppliers and represents our current actual knowledge based on the information they provided. This information is subject to change. The part numbers that TE has identified as EU RoHS compliant have a maximum concentration of 0.1% by weight in homogenous materials for lead, hexavalent chromium, mercury, PBB, PBDE, DBP, BBP, DEHP, DIBP, and 0.01% for cadmium, or qualify for an exemption to these limits as defined in the Annexes of Directive 2011/65/EU (RoHS2). Finished electrical and electronic equipment products will be CE marked as required by Directive 2011/65/EU. Components may not be CE marked. Additionally, the part numbers that TE has identified as EU ELV compliant have a maximum concentration of 0.1% by weight in homogenous materials for lead, hexavalent chromium, and mercury, and 0.01% for cadmium, or qualify for an exemption to these limits as defined in the Annexes of Directive 2000/53/EC (ELV). Regarding the REACH Regulation, the information TE provides on SVHC in articles for this part number is based on the latest European Chemicals Agency (ECHA) 'Guidance on requirements for substances in articles' posted at this URL: <https://echa.europa.eu/guidance-documents/guidance-on-reach>

### Compatible Parts

 <p>TE Part # 234912-1 EXT TOOL FOR POWER DBL LOK REC</p>	 <p>TE Part # 1-2336229-6 Power Versa-Lock PLUG, 2X3 KEY A</p>	 <p>TE Part # 1-2345728-1 Power Versa-Lock PLUG, 1X1 KEY A</p>	 <p>TE Part # 1-2378159-2 Power Versa-Lock PLUG, 1X2 KEY A</p>
 <p>TE Part # 1-2378159-3 Power Versa-Lock PLUG, 1X3 KEY A</p>	 <p>TE Part # 2-2336229-6 Power Versa-Lock PLUG, 2X3 KEY B</p>	 <p>TE Part # 2-2378159-2 Power Versa-Lock PLUG, 1X2 KEY B</p>	 <p>TE Part # 2-2378159-3 Power Versa-Lock PLUG, 1X3 KEY B</p>
 <p>TE Part # 2-2837358-1 OCEAN_2.0_Applicator-S-050F090OV</p>	 <p>TE Part # 2-2837358-2 OCEAN_2.0_Applicator-S-050F090OVA</p>	 <p>TE Part # 2837358-1 OCEAN_2.0_Applicator-S-050F090OV</p>	 <p>TE Part # 2837358-2 OCEAN_2.0_Applicator-S-050F090OVA</p>



TE Part # 3-2336229-6  
Power Versa-Lock PLUG, 2X3 KEY C



TE Part # 3-2378159-2  
Power Versa-Lock PLUG, 1X2 KEY C



TE Part # 3-2378159-3  
Power Versa-Lock PLUG, 1X3 KEY C



TE Part # 4-2378159-2  
Power Versa-Lock PLUG, 1X2 KEY D



TE Part # 5-2378159-2  
Power Versa-Lock PLUG, 1X2 KEY E



TE Part # 6-2378159-2  
Power Versa-Lock PLUG, 1X2 KEY F



TE Part # 7-2378159-2  
Power Versa-Lock PLUG, 1X2 KEY G



TE Part # 7-2837358-1  
OCEAN\_2.0\_Applicator-S-050F0900V

## Also in the Series | Power Versa-Lock 5.0



Insertion & Extraction Tools(2)



Power Contacts(8)



Rectangular Caps & Covers(3)



Rectangular Connector Locking(1)



Rectangular Connector Seals(6)



Rectangular Power Connectors(33)

## Customers Also Bought



TE Part #177901-1  
POWER DBL LOCK PLUG HSG 6P



TE Part #794440-1  
MINI UMNL PIN SN 22-18 AWG



TE Part #4438994002  
RT555-3/16-0-SP



TE Part #63895-1  
GROUND CLIP 14-18AWG ST

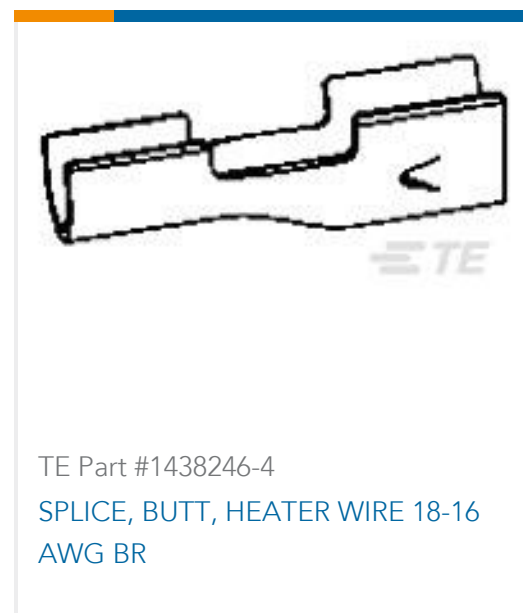

## Documents

### CAD Files

#### 3D PDF

3D

#### Customer View Model

[ENG\\_CVM\\_CVM\\_2329915-1\\_A.2d\\_dxf.zip](#)

English

#### Customer View Model

[ENG\\_CVM\\_CVM\\_2329915-1\\_A.3d\\_igs.zip](#)

English

#### Customer View Model

[ENG\\_CVM\\_CVM\\_2329915-1\\_A.3d\\_stp.zip](#)

English

By downloading the CAD file I accept and agree to the [Terms and Conditions](#) of use.

### Product Specifications

#### Application Specification

English

### Product Environmental Compliance

#### Product Compliance

English

#### Product Compliance

English

### Instruction Sheets

#### Instruction Sheet (U.S.)

English

2329915-1

Power Versa-Lock 5.0, Power Contacts, Contact, Operating Voltage 600 VAC,  
Operating Voltage 600 VDC, Pre-Tin, 26 – 22AWG Wire Size

