

SKiiP 24AC12T4V1

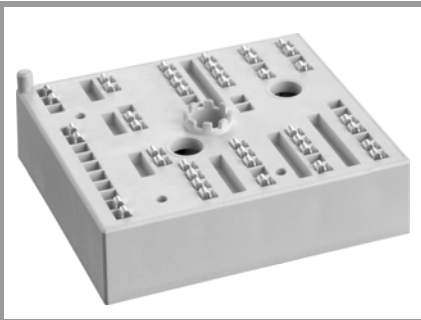

MiniSKiiP® 2

SKiiP 24AC12T4V1

Features

- Trench 4 IGBT's
- Robust and soft freewheeling diodes in CAL technology
- Highly reliable spring contacts for electrical connections
- UL recognised file no. E63532

Typical Applications*

- Inverter up to 22 kVA
- Typical motor power 11 kW

Remarks

- V_{CEsat} , V_F = chip level value
- Case temp. limited to $T_C = 125^\circ\text{C}$ max. (for baseplateless modules $T_C = T_S$)
- product rel. results valid for $T_j \leq 150$ (recomm. $T_{op} = -40 \dots +150^\circ\text{C}$)

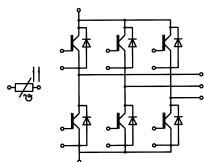

AC

Absolute Maximum Ratings			
Symbol	Conditions	Values	Unit
Inverter - IGBT			
V_{CES}	$T_j = 25^\circ\text{C}$	1200	V
I_C	$T_j = 175^\circ\text{C}$	$T_s = 25^\circ\text{C}$	52
		$T_s = 70^\circ\text{C}$	43
I_{Cnom}		35	A
I_{CRM}	$I_{CRM} = 3 \times I_{Cnom}$	105	A
V_{GES}		-20 ... 20	V
t_{psc}	$V_{CC} = 800\text{ V}$	$T_j = 150^\circ\text{C}$	10
	$V_{GE} \leq 15\text{ V}$		
	$V_{CES} \leq 1200\text{ V}$		
T_j		-40 ... 175	$^\circ\text{C}$
Inverse - Diode			
I_F	$T_j = 175^\circ\text{C}$	$T_s = 25^\circ\text{C}$	44
		$T_s = 70^\circ\text{C}$	35
I_{Fnom}		35	A
I_{FRM}	$I_{FRM} = 3 \times I_{Fnom}$	105	A
I_{FSM}	10 ms, sin 180°, $T_j = 150^\circ\text{C}$	170	A
T_j		-40 ... 175	$^\circ\text{C}$
Module			
$I_{t(RMS)}$	$T_{terminal} = 80^\circ\text{C}$, 20A per spring	100	A
T_{stg}		-40 ... 125	$^\circ\text{C}$
V_{isol}	AC sinus 50Hz, t = 1 min	2500	V

Characteristics					
Symbol	Conditions	min.	typ.	max.	Unit
Inverter - IGBT					
$V_{CE(sat)}$	$I_C = 35\text{ A}$ $V_{GE} = 15\text{ V}$ chipelevel	$T_j = 25^\circ\text{C}$	1.85	2.10	V
		$T_j = 150^\circ\text{C}$	2.25	2.45	V
V_{CE0}		$T_j = 25^\circ\text{C}$	0.8	0.9	V
		$T_j = 150^\circ\text{C}$	0.7	0.8	V
r_{CE}	$V_{GE} = 15\text{ V}$	$T_j = 25^\circ\text{C}$	30	34	m Ω
		$T_j = 150^\circ\text{C}$	44	47	m Ω
$V_{GE(th)}$	$V_{GE} = V_{CE}$, $I_C = 1\text{ mA}$	5	5.8	6.5	V
I_{CES}	$V_{GE} = 0\text{ V}$ $V_{CE} = 1200\text{ V}$	$T_j = 25^\circ\text{C}$	0.1	0.3	mA
					mA
C_{ies}	$V_{CE} = 25\text{ V}$ $V_{GE} = 0\text{ V}$	$f = 1\text{ MHz}$	1.95		nF
C_{oes}		$f = 1\text{ MHz}$	0.16		nF
C_{res}		$f = 1\text{ MHz}$	0.12		nF
Q_G	- 8 V...+ 15 V		200		nC
R_{Gint}	$T_j = 25^\circ\text{C}$		0.00		Ω
$t_{d(on)}$	$V_{CC} = 600\text{ V}$	$T_j = 150^\circ\text{C}$	21		ns
t_r	$I_C = 35\text{ A}$	$T_j = 150^\circ\text{C}$	31		ns
E_{on}	$R_{Gon} = 15\ \Omega$ $R_{Goff} = 15\ \Omega$	$T_j = 150^\circ\text{C}$	3.7		mJ
$t_{d(off)}$	$di/dt_{on} = 1300\text{ A}/\mu\text{s}$	$T_j = 150^\circ\text{C}$	310		ns
t_f	$di/dt_{off} = 460\text{ A}/\mu\text{s}$	$T_j = 150^\circ\text{C}$	63		ns
E_{off}	$V_{GE} = +15/-15\text{ V}$	$T_j = 150^\circ\text{C}$	3		mJ
$R_{th(j-s)}$	per IGBT		0.85		K/W

SKiiP 24AC12T4V1

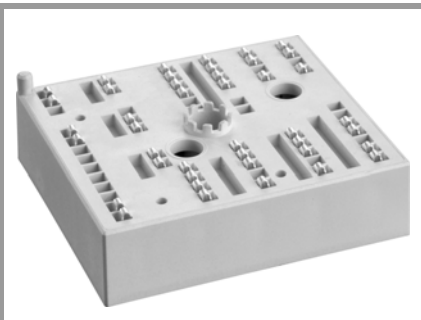

MiniSKiiP® 2

SKiiP 24AC12T4V1

Features

- Trench 4 IGBT's
- Robust and soft freewheeling diodes in CAL technology
- Highly reliable spring contacts for electrical connections
- UL recognised file no. E63532

Typical Applications*

- Inverter up to 22 kVA
- Typical motor power 11 kW

Remarks

- V_{CEsat} , V_F = chip level value
- Case temp. limited to $T_C = 125^\circ\text{C}$ max. (for baseplateless modules $T_C = T_S$)
- product rel. results valid for $T_j \leq 150$ (recomm. $T_{op} = -40 \dots +150^\circ\text{C}$)

Characteristics						
Symbol	Conditions		min.	typ.	max.	Unit
Inverse - Diode						
$V_F = V_{EC}$	$I_F = 35 \text{ A}$ $V_{GE} = 0 \text{ V}$ chiplevel	$T_j = 25^\circ\text{C}$		2.3	2.6	V
		$T_j = 150^\circ\text{C}$		2.3	2.6	V
V_{F0}		$T_j = 25^\circ\text{C}$		1.3	1.5	V
		$T_j = 150^\circ\text{C}$		0.9	1.1	V
r_F		$T_j = 25^\circ\text{C}$		29	32	m Ω
		$T_j = 150^\circ\text{C}$		40	43	m Ω
I_{RRM}	$I_F = 35 \text{ A}$	$T_j = 150^\circ\text{C}$		38		A
Q_{rr}	$di/dt_{off} = 1400 \text{ A}/\mu\text{s}$	$T_j = 150^\circ\text{C}$		6.2		μC
E_{rr}	$V_{GE} = -15 \text{ V}$ $V_{CC} = 600 \text{ V}$	$T_j = 150^\circ\text{C}$		2.3		mJ
$R_{th(j-s)}$	per Diode			1.2		K/W
Module						
M_s	to heat sink		2		2.5	Nm
w				65		g
Temperatur Sensor						
R_{100}	$T_C = 100^\circ\text{C}$ ($R_{25} = 1000\Omega$)			1670 \pm 3%		Ω
$R(T)$	$R(T) = 1000\Omega [1 + A(T - 25^\circ\text{C}) + B(T - 25^\circ\text{C})^2]$], $A = 7.635 \cdot 10^{-3} \text{ }^\circ\text{C}^{-1}$, $B = 1.731 \cdot 10^{-5} \text{ }^\circ\text{C}^{-2}$					

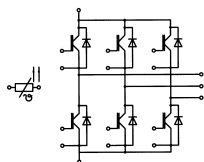

AC

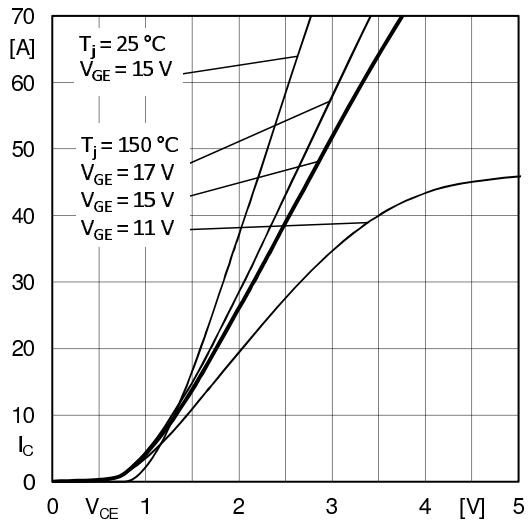

Fig. 1: Typ. output characteristic, inclusive $R_{CC'+EE'}$

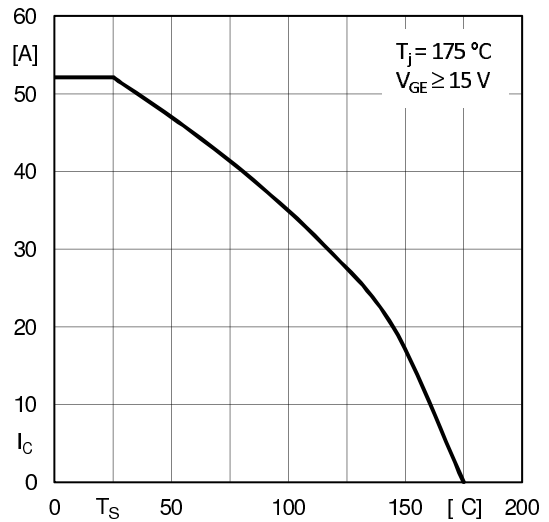

Fig. 2: Rated current vs. temperature $I_C = f(T_S)$

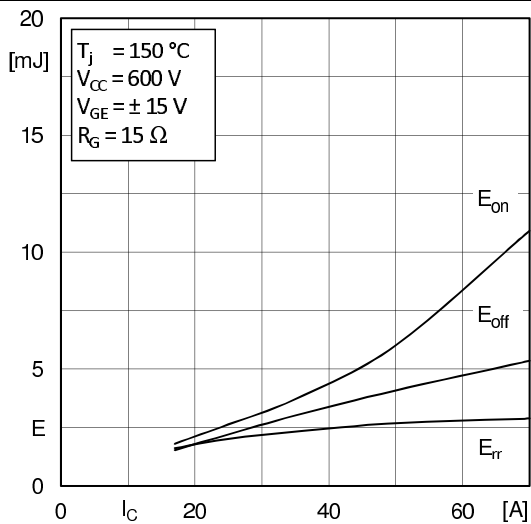

Fig. 3: Typ. turn-on /-off energy = $f(I_C)$

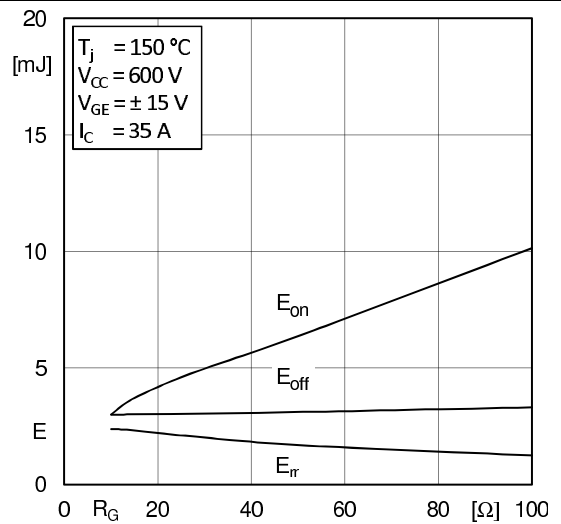

Fig. 4: Typ. turn-on /-off energy = $f(R_G)$

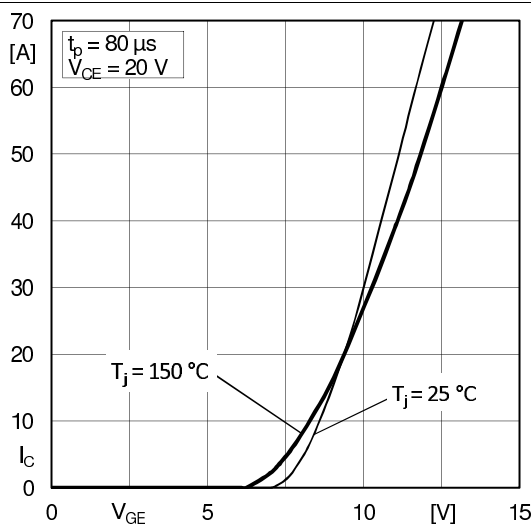

Fig. 5: Typ. transfer characteristic

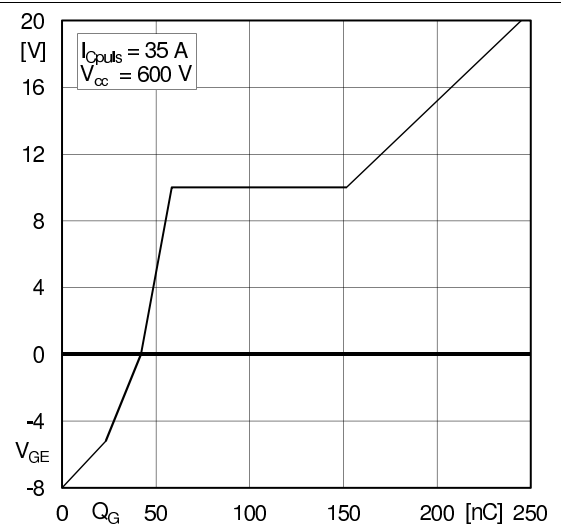

Fig. 6: Typ. gate charge characteristic

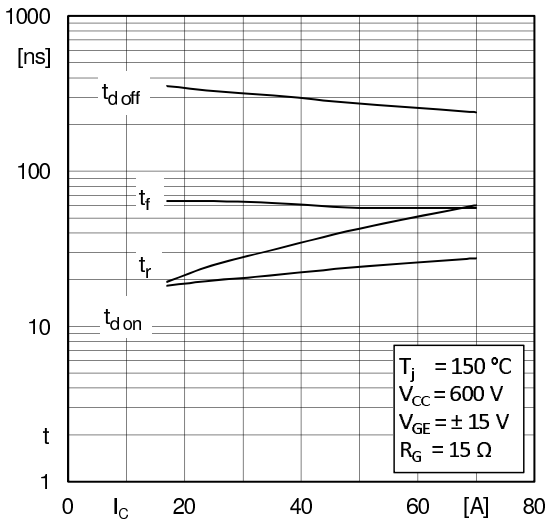

Fig. 7: Typ. switching times vs. I_C

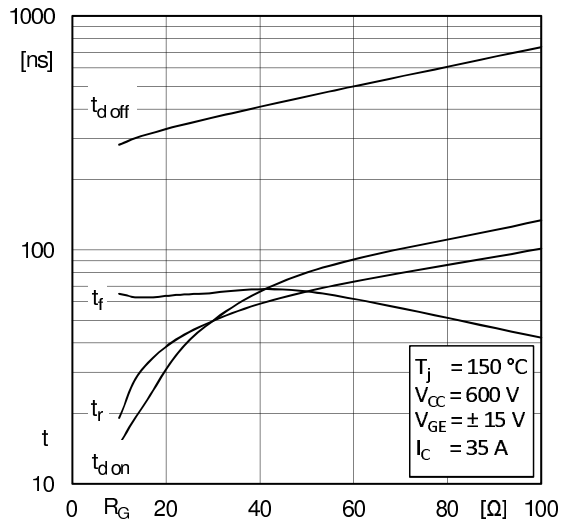

Fig. 8: Typ. switching times vs. gate resistor R_G

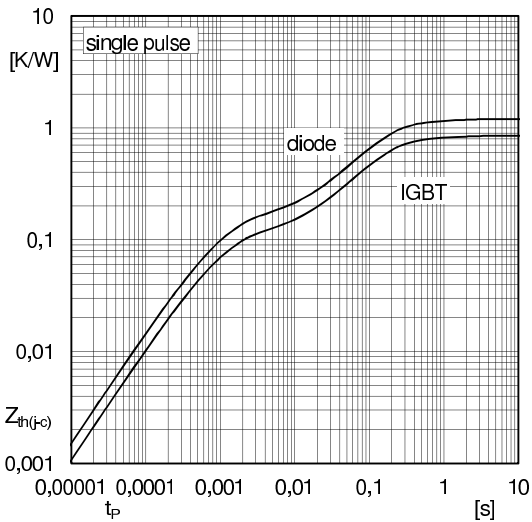

Fig. 9: Transient thermal impedance of IGBT and Diode

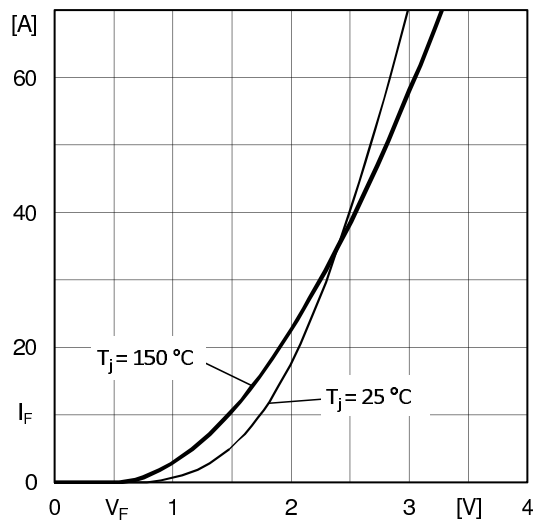

Fig. 10: CAL diode forward characteristic

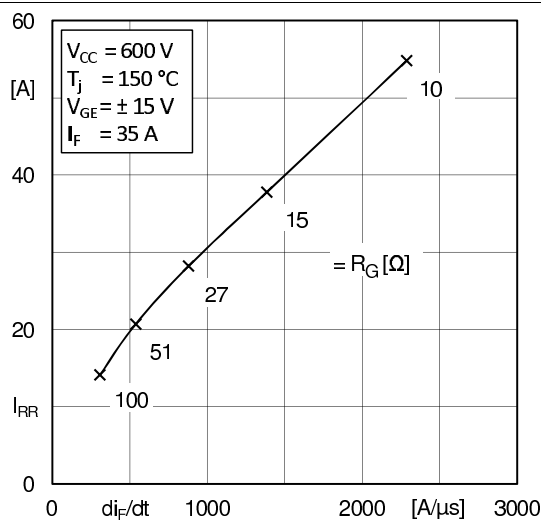

Fig. 11: Typ. CAL diode peak reverse recovery current

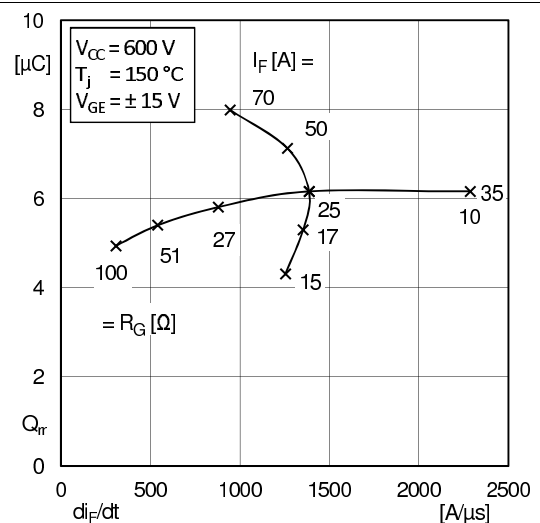
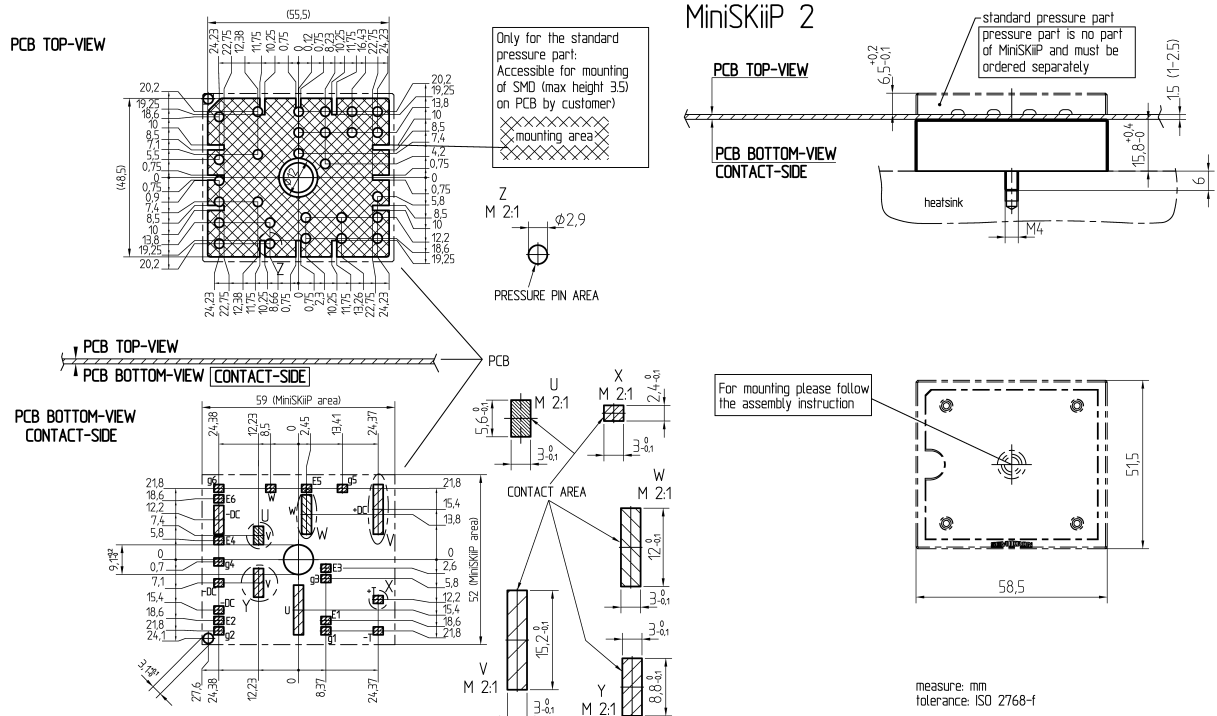

Fig. 12: Typ. CAL diode recovery charge

SKiiP 24AC12T4V1



These documents are Semikron property. Semikron reserves all copyrights. All copying and transmitting of this information requires written permission. For the case of industrial property rights, Semikron reserves all rights.

pinout, dimensions

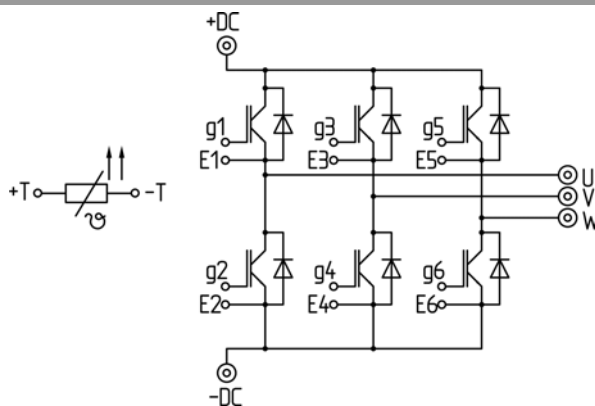

- ⊙ power connector
- control connector

pinout

This is an electrostatic discharge sensitive device (ESDS), international standard IEC 60747-1, Chapter IX

* The specifications of our components may not be considered as an assurance of component characteristics. Components have to be tested for the respective application. Adjustments may be necessary. The use of SEMIKRON products in life support appliances and systems is subject to prior specification and written approval by SEMIKRON. We therefore strongly recommend prior consultation of our staff.